

Systeme de cloison à ossature métallique qui intègre une porte sans cadre à charnières invisibles bi-affleurante. Pour cloisons 72/48 et 98/48.

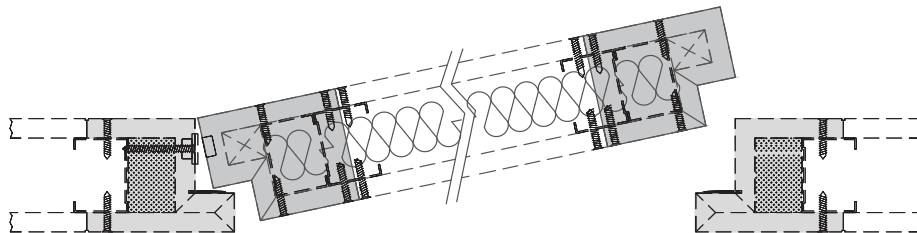

Contenu du paquet →

- 1 Bâti Monobloc
- 2 Vantail Pure Line
- 3 Barre d'écartement
- 4 Joint isophonique
- 5 Gâche
- 6 Charnières invisibles 3D
- 7 Vis charnières
- 8 Vis de mise en bloc + vis d'écratement

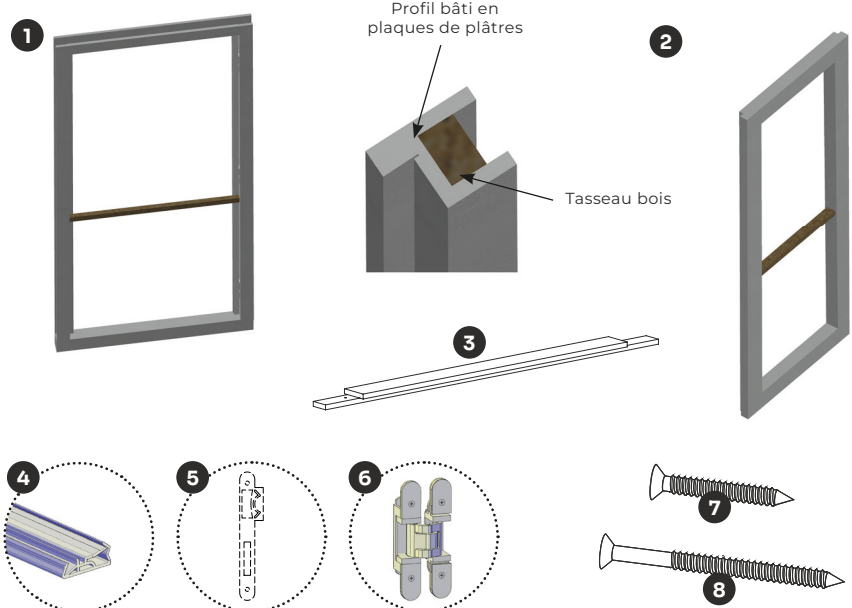

01.

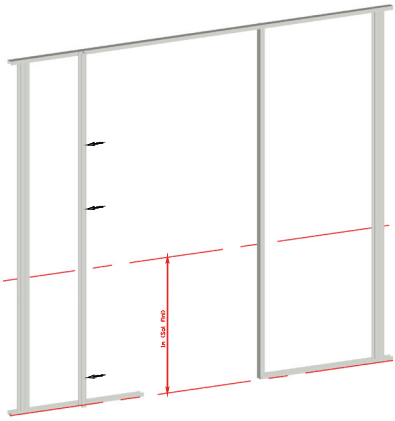

Fixer le premier rail au trait d'1m

02.

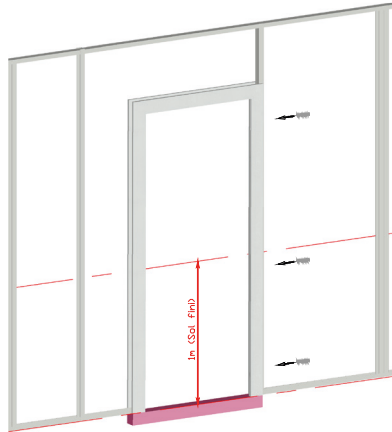

Positionner le bâti et le fixer

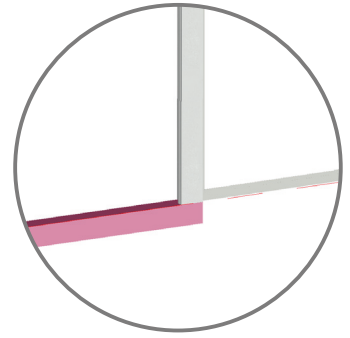

03.

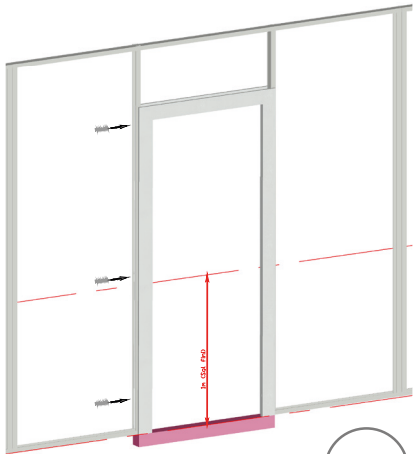

Positionner le 2ème montant et le fixer



04.

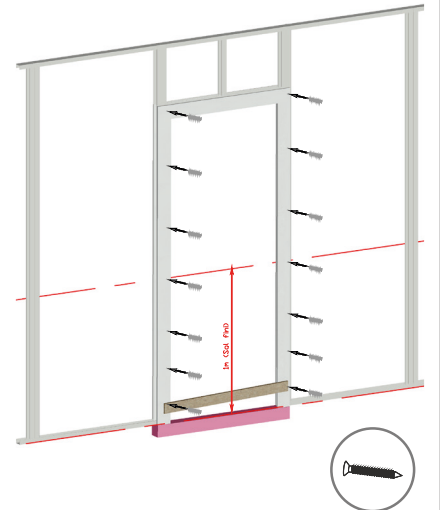

Installer le chevêtre et fixer selon le DTU 25-41

05.

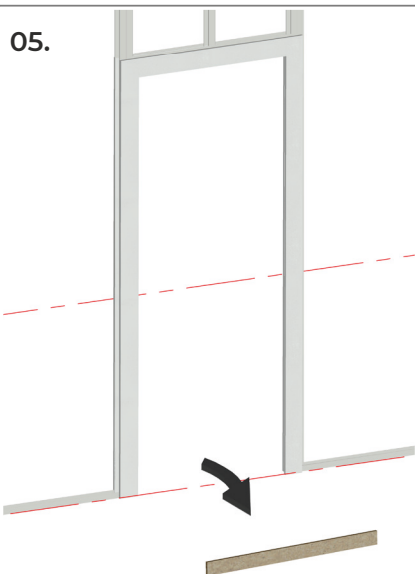

Dévisser la barre d'écartement

06.

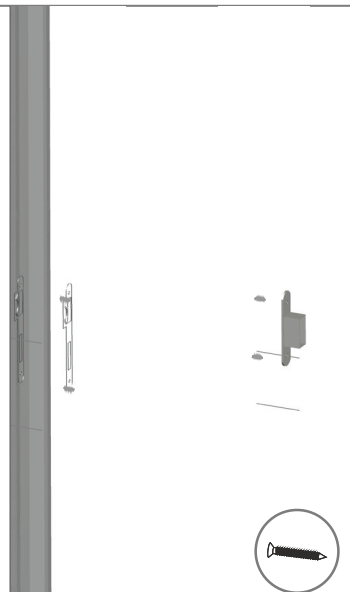

Fixer les charnières et gâche

07.

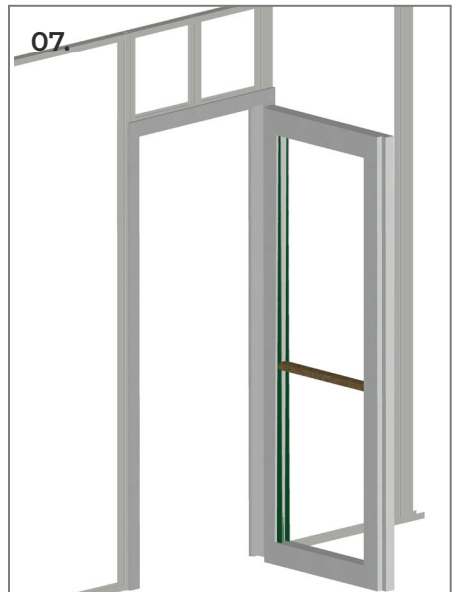

Installer le vantaill sur la cloison

